

SmartBox® 4 / SmartBox® 4 PRO

Electronic remote level gauge with remote data transmission



CONTENTS

CERTIFICATE.....	1
GENERAL PRODUCT INFORMATION.....	2
SAFETY ADVICE.....	2
ABOUT THE MANUAL.....	3
INTENDED USE.....	3
INAPPROPRIATE USE.....	4
USER QUALIFICATION.....	4
ASSEMBLY.....	4
ELECTRIC CONNECTION.....	6
ELECTRICAL INSTALLATION.....	6
START-UP.....	8
PROGRAMMING.....	11
EXAMPLES FOR PROGRAMMING.....	15
NOTES ON PROGRAMMING.....	16
PROGRAMMING THE REMOTE MONITORING FUNCTIONS.....	19
LIST OF COMMANDS.....	21
OPERATION.....	25
TROUBLESHOOTING.....	25
FUNCTION CHECK / MAINTENANCE.....	26
RESTORATION.....	26
LIST OF ACCESSORIES.....	27
DISPOSAL.....	27
PROBES AND ACCESSORY PARTS.....	27
TECHNICAL DATA.....	28
WARRANTY.....	28
TECHNICAL CHANGES.....	28

CERTIFICATE

Our management system is certified according to ISO 9001, ISO 14001 and ISO 50001, see:

www.gok.de/qualitaets-umwelt-und-energiemanagementsystem.



GENERAL PRODUCT INFORMATION

The electronic tank management system **SmartBox® 4** and **SmartBox® 4 PRO** can be used for remote monitoring of the liquids contained in unpressurized liquids tanks.

In addition to the registration of tank content and remote data transfer, other functions can be implemented by system enhancements, e. g. temperature measurement, message about system fault or connection to master control systems of the building. A Nano-SIM card is required for remote data transmission.

Typically, a message will be received by the accounting management system **www.smart-inspector.com**. Optionally, the messages can be received on any mobile phone.

The **SmartBox® 4** has relay control functions, e. g. for activating external alarm devices, solenoid valves, or the dry-run protection function of pumps.

Via an integrated interface, a maximum of three more content indicators **SmartBox® 1, 2 or 3** can be connected whose measurements are also telecommunicated.

SmartBox® 4 PRO allows the content of up to four tanks to be recorded and monitored remotely.

Because of its modular design, the system can be modified to suit many different applications. The indicated measurements are not calibrated for invoicing.

SmartBox® 4 has a 2-line LCD display, a measuring input for connecting the probe, a programmable relay with make and break switching output, a fault message input and an integrated GSM modem for remote data transmission.

SmartBox® 4 PRO has a 2-line LCD display, four measuring inputs to connect the probes, a fault message input and an integrated GSM modem for remote data transmission.

SAFETY ADVICE

Your safety and the safety of others are very important to us. We have provided many important safety messages in this assembly and operating manual.

✓ Always read and obey all safety messages.



This is the safety alert symbol.

This symbol alerts you to potential hazards that can kill or hurt you and others. All safety messages will follow the safety alert symbol and either the word "DANGER", "WARNING", or "CAUTION". These words mean:

▲ DANGER

describes a **personal hazard** with a **high degree of risk**.

→ May result in **death or serious injury**.

▲ WARNING

describes a **personal hazard** with a **medium degree of risk**.

→ May result in **death or serious injury**.

▲ CAUTION

describes a **personal hazard** with a **low degree of risk**.

→ May result in **minor or moderate injury**.

NOTICE describes **material damage**.

→ Has an **effect** on ongoing operation.



describes a piece of information



describes a call to action

ABOUT THE MANUAL



- This manual is part of the product.
- This manual must be observed and handed over to the operator to ensure that the component operates as intended and to comply with the warranty terms.
- Keep it in a safe place while you are using the product.
- In addition to this manual, please also observe national regulations, laws and installation guidelines.

This assembly and operating manual is aimed at users and operators of this product. These persons must have read and understood the assembly and operating manual.

⚠ The physical and psychical requirements for proper and safe handling of the product must be ensured at all times!

INTENDED USE

Operating media

Operating media with consideration of the otherwise suitable probe type and accessories, see:



Please comply with the “Level gauge type FSA-W 4-20 mA for SmartBox® 1 – 4” assembly and operating manual!



Comply with the “Level probe” assembly and operating manual!



You will find a **list of operating media** with descriptions, the relevant standards and the country in which they are used in the Internet at www.gok.de/liste-der-betriebsmedien.



⚠ WARNING Escaping, liquid operating media:

- are hazardous to the aquatic environment
- are inflammable category 1, 2 or 3 liquids
- can ignite and cause burning
- can cause injury through people falling or slipping
- ✓ Capture operating media during maintenance work.

Installation location

- with protection type IP54, indoors and outdoors, if protected against the weather



⚠ DANGER May not be used in potentially explosive areas.

Can cause an explosion or serious injuries.

- ✓ Must be installed by a specialised company in accordance with local industrial health and safety regulations.
- ✓ Installation outside the defined EX protection zone.

NOTICE Malfunctions caused by flooding!

The product is not designed for installation in areas prone to flooding or risk areas.

- ✓ Following flooding, the product must be replaced!



INAPPROPRIATE USE

All uses exceeding the concept of intended use:

Display unit:

- changes to the product or parts of the product
- installation in a potentially explosive area
- weather-protected outdoor use without protection type IP54

Probe:

- e.g. operation with different operating media
- operation with inflammable operating media of categories 1, 2 or 3 with a flash point < 55°C¹⁾
- installation in pressurised tanks and containers

¹⁾ It is also necessary to comply with the divergent provisions/regulations of the EU member states concerning areas at risk of explosion and the flash point of the operating medium!

USER QUALIFICATION

This product may be installed only by qualified experts. These are personnel who are familiar with setting up, installing, starting up, operating and maintaining this product.

"Equipment and systems requiring supervision may be operated only by persons aged at least 18, who are physically capable and who have the necessary specialist knowledge or who have been instructed by a competent person. Instruction at regular intervals, but at least once per year, is recommended."

Activity	Qualification
storing, transporting, unpacking, OPERATION	trained personnel
ASSEMBLY, MAINTENANCE START-UP, SHUT-DOWN, REPLACEMENT, RESTART, RESTORATION, DISPOSAL,	qualified personnel, customer service
ELECTRICAL INSTALLATION	qualified electrician

ASSEMBLY

Before assembly, check that the product is complete and has not suffered any damage during transport.

ASSEMBLY must be carried out by a specialised company.



The specialised company and the operator must observe, comply with and understand all of the following instructions in this assembly and operating manual. For the system to function as intended, it must be installed professionally in compliance with the technical rules applicable to the planning, construction and operation of the entire system.

These regulations also include the accident prevention regulations of the employers' liability insurance associations, the VDE regulations, and the installation and operating instructions.

NOTICE The housing of the display unit is suitable for wall mounting and is connected to the 230 V mains supply. Under normal circumstances, the display unit must be operated with the housing cover closed.

! It is installed and started up by a qualified technician while the unit is open.



! WARNING

Do not use this device for safety applications or emergency stop mechanisms or misuse it!

Injuries and damage to health and property through misuse.

- ✓ You must observe the information contained in these instructions, especially regarding installation, start-up and maintenance.



⚠ DANGER Damaged or destroyed insulation!

Can result in short circuit or electric shock.

- ✓ Do not use the device if the insulation is damaged!
- ✓ Have new insulation installed by a specialised company!

Selecting an installation location / Checking the reception quality of the mobile phone network

Before installing the SmartBox®, you must check whether the reception quality of the applicable telecommunications network is sufficient. The easiest way to do this is to have a mobile phone ready at the designated place of installation. As a precondition, the mobile phone must be registered with the same telecommunications network (in Germany e. g. T-Mobile, Vodafone, O₂) as the SIM card which is used for the SmartBox®.

If there is no suitable mobile phone at hand, you can also perform the test with the SIM card for the SmartBox®. In this case, insert this **activated** SIM card into a mobile phone and switch it on again.

The reception quality at the designated place of installation can simply be seen from the indication in the mobile phone screen. At least one bar/scale line of the reception quality indicator must be visible on the screen. If the reception quality is very bad (no bar/scale line visible), another installation site should be picked and tested (possibly in another room). If the reception quality is very bad, an additional antenna (accessory) should be used. It can be installed e. g. in front of a basement window.

Installation of the display unit

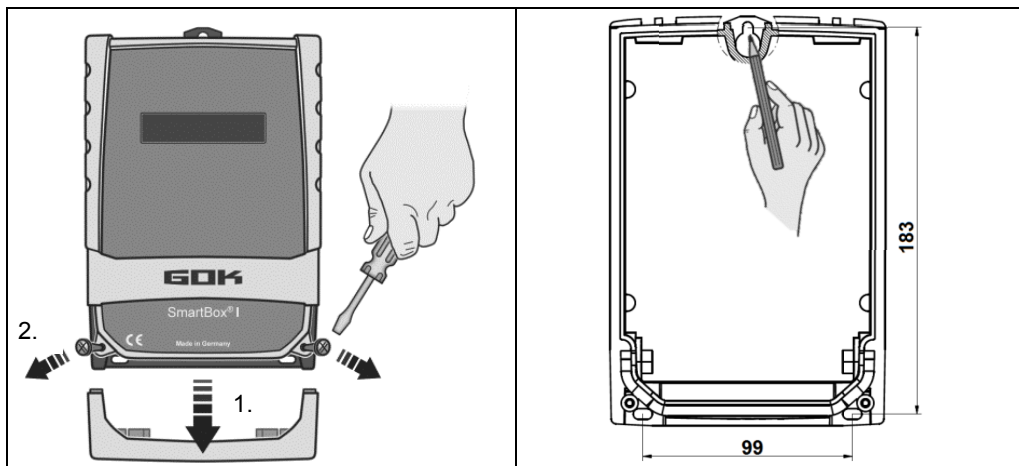

Mount the display unit to the wall in a suitable position.

1. Open the display unit by removing the bottom cover.
2. After loosening the 2 screws, open the display unit by removing the cover.
3. Mount the display unit to a smooth vertical wall by means of dowels by the four fixing holes with the enclosed screws and anchors. Take care not to damage the housing.
4. After connecting the terminals and setting the unit up, replace the covers.

Installing the level probe



See assembly and operating instruction "Level probe".



Installing the probe

i See assembly and operating instruction „FSA-W 4-20 mA level gauge for SmartBox® 1 – 4“.



i ELECTRICAL INSTALLATION see corresponding instruction „FSA-W 4-20 mA level gauge for SmartBox® 1 – 4“.



ELECTRIC CONNECTION

Safety precautions for electrical components

⚠ CAUTION The functions and operating safety of the device are guaranteed only under the climatic conditions that are specified in TECHNICAL DATA. If the device is transported from a cold to a warm environment, condensation may cause the device to malfunction or may even destroy the device. Because of this, you must ensure that the device has acclimatised to the ambient temperature before using it.

⚠ CAUTION If you have any doubts that the device can be operated safely, do not operate it. Your safety may be adversely affected by the device, if for example:

- it is obviously damaged
- it no longer works as specified
- it has been stored in unsuitable conditions for some time, if in doubt, send the device to the manufacturer for repair or maintenance

Connection line between display unit and level probe

Voltage	Probe supply 20 V DC			
Connection	Level probe connection cable	+	-	
SmartBox® 4	Level probe - terminals	1	2	→ Tank 1 Fig. ①
SmartBox® 4 PRO	Level probe 1 - terminals	3	4	→ Tank 1 Fig. ②
	Level probe 2 - terminals	5	6	→ Tank 2
	Level probe 3 - terminals	7	8	→ Tank 3
	Level probe 4 - terminals	9	10	→ Tank 4

ELECTRICAL INSTALLATION

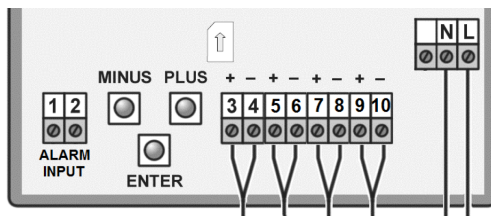

SmartBox® 4 PRO

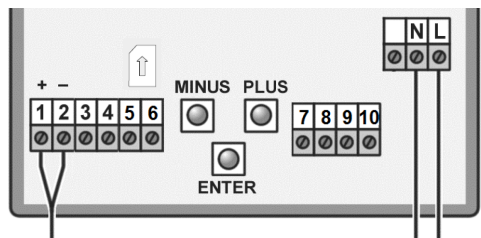

SmartBox® 4

Connection of supply voltage: Voltage: 230 V AC 50 Hz

Connection: Terminals N + L to the display unit (cable not included in the delivery)

Connection of relay contacts at the indicator SmartBox[®] 4

The Indicator SmartBox[®] 4 has two relay contact pairs for the connection of external control circuits or for activating external alarm or signal devices.

In case of failure of the unit and if the fill level (and optionally temperature) is above / below the selected limit, the contacts of relay terminals **7 + 8** are closed, or **9 + 10** are open - see the legend on the PCB in the unit.

⚠ CAUTION Switching voltage max. 250 V AC 
 Switching current max. 3,5 A

Switching contact	normally closed (NC)	normally opened (NO)
Relay	Terminals 7 + 8	Terminals 9 + 10

SmartBox[®] 4

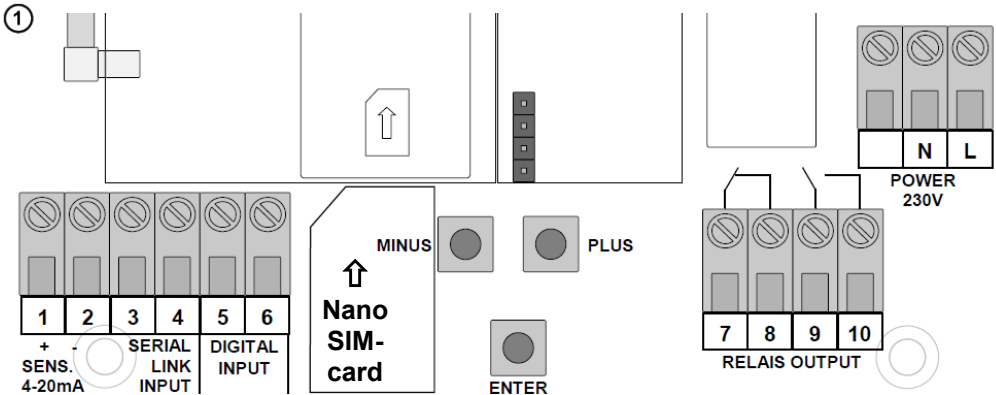

⚠ WARNING Excess voltage!

Damage to components and device defect.

- ✓ No 230 V AC connections may be made to terminals **3 + 4** and **5 + 6** or probe input terminals **1 + 2**!

Connction of the interface SmartBox[®] 4 to SmartBox[®] 1, 2 or 3

Via the integrated interface "SERIAL LINK INPUT" (terminals 3 + 4), a maximum of three additional indicators SmartBox[®] 1, 2 or 3 can be connected and the measured values for the additional tanks (tank 2 to tank 4) can be telecommunicated.

For SmartBox[®] 1 and 2, the two-pole output terminal "Serial Link Output" (terminals 3 + 4) is con-nected to terminals 3 + 4 (terminal 3 → 3 and 4 → 4) of the SmartBox[®] 4 with a two-core cable (e. g. 2 x 0.4 mm²).

If the tanks should be numbered in a defined sequence (tank 2 to 4), then SmartBox[®] 4 must be activated first, followed by the other indicators in the desired sequence.

SmartBox® 4 PRO

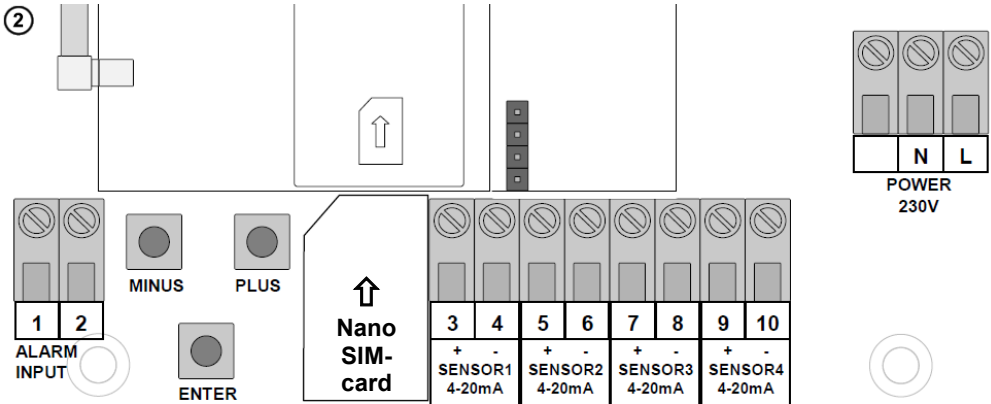

⚠ WARNING Excess voltage!

Damage to components and device defect.

- ✓ No 230 V AC connections may be made to terminals **3 + 4, 5 + 6, 7 + 8 and 9 + 10** or terminals **1 + 2** „ALARM INPUT“!

Connection of the fault signal input

A switch contact (make or break contact) can be connected to the fault message input; for a burner fault signal, for example. If a fault occurs, an SMS text is sent to the administrator's mobile phone (with an approx. 5-minute delay).

SmartBox® 4	Terminal 5 + 6 “DIGITAL INPUT“
SmartBox® 4 PRO	Terminal 1 + 2 “ALARM INPUT“

Installation of the SIM card

A Nano-SIM card must be inserted into the GSM radio module (works with prepaid or contract card).

NOTICE The SIM card must have been registered i.e. activated!

The credit on a prepaid card can be topped up again. When a contract card is used, the transmission fees for the SMS are debited to the holder of the contract.

START-UP

Operation elements and display

The device is adjusted once when it is put into operation. After start-up the device operates in display mode with the top closed.

The display is a two-line LCD display with 2 x 16 characters.

The display has blue background lighting for best readability in all lighting conditions.

NOTICE

After the level indicator has been installed, it can be started up.

Before activating power supply, check whether the SIM card is correctly inserted in the radio module! (The SIM card must be fully inserted and locked in place).

SmartBox[®] 4 / SmartBox[®] 4 PRO has the following display:

<p>The image shows the SmartBox 4 control panel. At the top is a digital display with two lines: 'Heat oil L' and 'Fillspace L %'. Below the display is the 'SmartBox[®] 4' logo. The control panel features several buttons: 'MINUS' and 'PLUS' (top left), 'ENTER' (middle left), 'ALARM INPUT' (bottom left), and a numeric keypad (1-10) with '+' and '-' signs above it. To the right of the keypad are terminals for 'N' and 'L'. Wires connect the keypad to the terminals.</p>	<p>The device is adjusted via the three small blue buttons:</p>
<p>A close-up of the three small blue buttons: 'MINUS', 'PLUS', and 'ENTER'.</p>	<p>These are located on the motherboard between the terminals.</p>
<p>Choosing the language (German, English, French or Spanish) in Step "18. Language+Names".</p>	

⚠ WARNING Activating power supply:
Keep away from the area of the 230 V terminal!

- **⚠ Activate power supply** – the following is displayed alternately

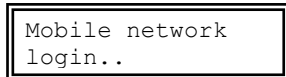
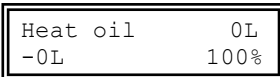

- After some seconds, "**PIN:**" appears - now, enter the PIN code for the SIM card (you need to do this only once). Set the code with **PLUS** and confirm with **ENTER** (**[+] _ [Enter] [+] _ [Enter] [+] _ [Enter] [+] _ [Enter]**)
- The device saves the entered PIN code for the next dial-in. It will be available also after a power failure.

After you have entered the PIN code, the SmartBox[®] automatically attempts to log into the mobile network. This takes approx. 1 - 2 minutes, Display "**Netzsuche..**" (Mobile network login). When the dial-up is successful, "**Netzsuche..**" (Mobile network login) is no longer displayed. If login is impossible, the error message "ErrorM5" (see page 26) will be indicated. In problematic cases, login to the mobile network should be possible after installation of an external additional antenna. (HF antenna with wall bracket and 5 m connecting cable).

Fuel oil tank - wiring example SmartBox[®] 4

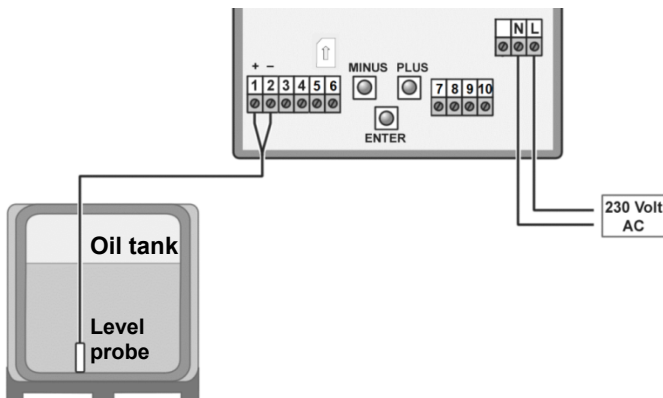

Fuel oil tank - wiring example SmartBox® 4 PRO

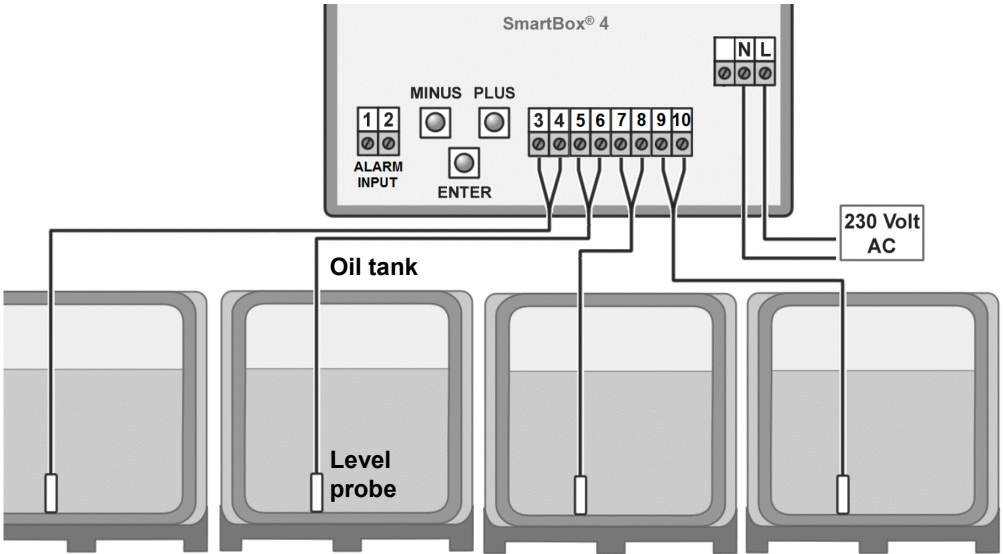

Rain water reservoir - wiring example SmartBox® 4

Relay 7-8 = break contact
=> pump safe to run dry

Relay 9-10 = make contact
=> automatic backfeed control system

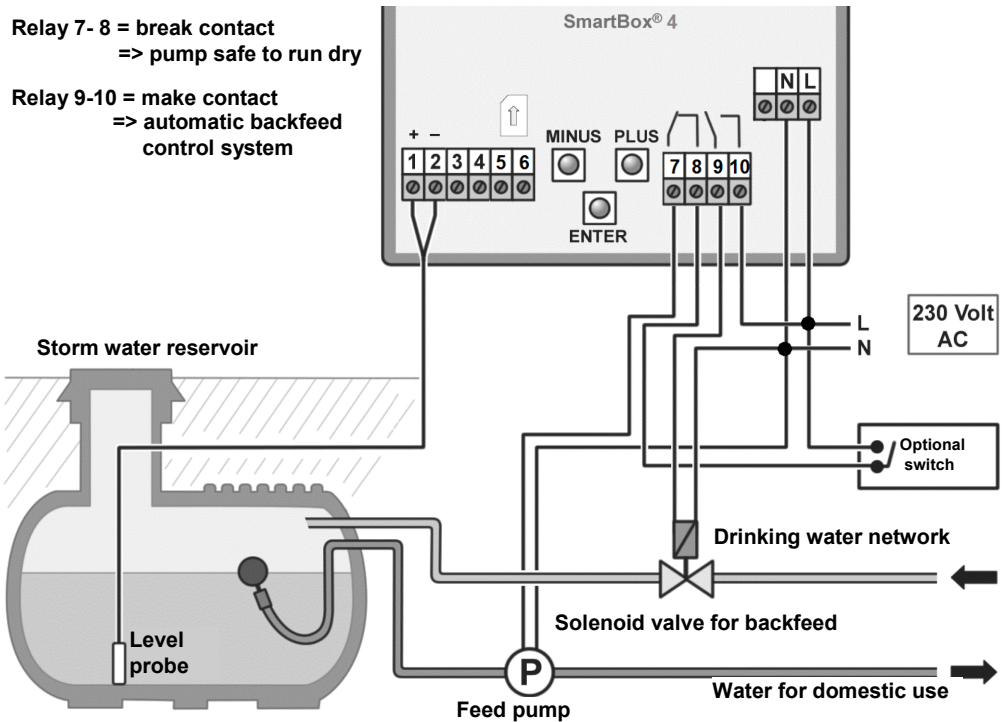

PROGRAMMING



⚠ WARNING Overfilling of the tank due to incorrect entry values.

Operating media may leak. These:

- are hazardous to water,
- are category 1,2 and 3 inflammable liquids,
- can ignite and cause burning,
- may cause falling injuries due to slipping.

✓ Enter these values with care!











The entry values are also retained in the event of the failure of the supply voltage.



Programming the level gauge

Before programming, you need to ascertain the tank data and enter the values into the right column (Input value) of the following table. Then, enter the values for the individual entry steps.

Setting a parameter:	Press [ENTER] to open setup mode. Select the desired setting parameter via [PLUS]. Press [ENTER] to call up the value selection for the parameter. Set the value with [MINUS]/[PLUS], press [ENTER] to save.
Quitting the setup mode:	You can quit the setup mode at any time. Select "Exit" and press [ENTER] → to go back to the standard display mode.

Menu	Input function			Input value
Tank: 1 → SmartBox 4 PRO	Select the tank (tank: 1 to tank: 4) to enter the corresponding values. (This step is not displayed if only one probe is connected to SmartBox® 4 PRO.)			Tank: _____
0.Exit	Press [ENTER] to return to display mode			
1.Measure probe	Select probe measuring range see type label of the probe - default setting 250 mbar			_____ mbar
	Standard probe	max. tank height for		
		fuel oil	water	
	100mbar	1.20m	1.00m	
	150mbar	1.80m	1.50m	
	160mbar	1.90m	1.60m	
	200mbar	2.40m	2.00m	
	250mbar	2.90m	2.50m	
	400mbar	4.70m	4.00m	
	500mbar	6.00m	5.00m	
	1.000mbar	12.00m	10.00m	
	2.000mbar	24.00m	20.00m	
	3.000mbar	36.00m	30.00m	
	5.000mbar	60.00m	50.00m	
set mbar				

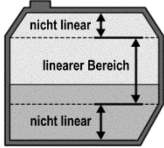
Menu	Input function	Input value
2. Liquid	Select the medium	
	Medium	Density value kg/m³ (15 °C)
	Heat. oil	845kg/m ³ - default setting
	Water	999kg/m ³
	Diesel	830kg/m ³
	Biodiesel	880kg/m ³
	RME, FAME	880kg/m ³
	Rape oil	915kg/m ³
	Palm oil	910kg/m ³
	Motor oil	865kg/m ³
	AdBlue	1090kg/m ³
	Regular gasoline	743kg/m ³
	Premium gasoline	750kg/m ³
Density value	Enter a special density value with different measuring range	<p>_____ kg/m³</p> <p>If the density of the stored medium is unknown, the reference height can be entered in menu item "10.Trim height"</p>
3. Tank shape	Select Tank shape with [Enter]	
Linear	Default setting linear tank, rectangular tanks, vertical cylinders, basement-welded steel tanks.	
Cylinder horizontal	cyindrical tank with arched ends horizontal tanks, tubular tanks typical shape for steel outdoor or buried tanks.	
Ball-shaped	spherical tank; buried tanks with spherical basic shape; frequently plastic buried tank (GRP).	
Oval	oval basement tanks; typical shape of GRP tanks and single-walled sheet metal tanks	
Convex	Plastic battery tanks, convex , slightly convex shape, alternative to linear	
Concave	Plastic battery tanks, concave , slightly concave shape, alternative to linear	
Holed plastic	Plastic tank with recess Plastic tank with a large recess (hollow) in the center (without tape bindings)	
Tube w. flat ends	Lying cylindrical tank with flat ends, tube segment with straight end plates. Typical tank shape for smaller diesel tanks.	
Metal oil tanks	Plate tank or plate tank battery linear side walls, with semicircular arc top and bottom.	

Menu	Input function	Input value						
Bearing chart	Enter a special tank shape from existing bearing chart. For this purpose, up to 16 value pairs (height in cm + volume in L) can be entered. Before the value pairs are entered, the values for the tank volumes must be entered in in steps "4.Tank volume" and "5. Internal tank height".							
Index: 0 → 0 cm → 0 L →	Specified value pair (do not have to be entered).							
Index: 1 → xxx.x cm → xxxx L Index: 2 → . cm → L Index: 3 → . cm → L max. Index:16 → max. cm → max. L	first value pair entered max. inside height of tank → the max. tank volume menu step "5.Internal tank height" is allocated automatically and does not have to be entered.							
Not all 15 intermediate value pairs (Index: 1 - 15) have to be entered. A linear interpolation is made between 2 interpolation values. For a linear range of the tank geometry it is sufficient to enter a lower and an upper value pair.								
Menu	Input function	Input value						
4.Tank volume	Adjust the tank volume with [+] / [-] (100%). The default setting is 0 L. The value must be set.  Please see a volume table for the highest value, if available. For a 100 m³ cyl. buried tank, this may for example be the value 100600 litres.	_____ L						
5.Tank height	Enter inner tank height in millimetres: e. g.: 249 cm (max. value = 999,9 cm) (height without dome)  Please see a volume table for the highest value, if available. For a 100 m³ cyl. buried tank, this may for example be the value 288 cm.	_____ mm						
5b.Filling limit	Set the filling limit of the tank with [+] / [-]: With fuel oil tanks, that is the shut-off point of the limit indicator. The default setting is 95%. e.g. 95%=237cm. For tanks which can be filled to the very top (e.g. water tanks), it is necessary to set the highest value of 99%.	_____ %						
6.View →SmartBox 4	In the 1st line of the display, the tank name/medium and contents are displayed (e.g. in litres). The display in the 2nd line can be selected: View details e.g. Single/detailed	<table border="1"> <tr> <td>Fillspace+Percent</td> <td>a)</td> </tr> <tr> <td>Fillspace+Level</td> <td>b)</td> </tr> <tr> <td>Percent+Level</td> <td>c)</td> </tr> </table>	Fillspace+Percent	a)	Fillspace+Level	b)	Percent+Level	c)
Fillspace+Percent	a)							
Fillspace+Level	b)							
Percent+Level	c)							
	For fuel oil tanks in Germany, a free capacity display is required according to TRwS 791-2. This is possible with selection a) and b).	_____						

Menu	Input function		Input value
6.View Tanks → SmartBox 4 Pro	Single/Detailed		The tanks are displayed cyclically one after the other, with L, % and, if applicable, temperature. With display change.
	Collective		The (eg. L) values of tanks 1 to 4 are displayed (depending on the number of connected probes) Without display change.
	Percent	Yes No	Select Yes → display change values (eg. in L) Tank 1 – 4 → total capacity display + percent values
⚠ WARNING Entering incorrect switching points and mixing up the switch-on and shut-off point can lead to the overfilling of the tank or the dry running of a pump!			
Menu	Input function		Input value
7.Relay → SmartBox 4	Switch function relay:		
	Deactive	The relay does not switch.	
	Active	The relay switches .	
	On	Forces the relay to energise.	
	Off	Forces the relay to de-energise.	
Active+SMS	When the relay switches over a message is output		
	Example of switch point setting for Active (with hysteresis): Enter switching points as % values from 01 - 99 (and/or enter as °C value from -99 to +99 only for probe with temperature measurement) deactive → activate with [+] / [-] to active → press [Enter] to confirm → On 10% → ON: set with [+] / [-] → [Enter] Off 12% → OFF: set with [+] / [-] → [Enter] On +0°C → ON: set with [+] / [-] → [Enter] Off +0°C → OFF: set with [+] / [-] → [Enter] Deactivate the relay via deactive or input of 0% or 0°C (for On and Off).		ON _____ % OFF _____ % ON _____ °C OFF _____ °C
7.Exit → SmartBox 4 PRO	Press [Enter] to return to display mode		
8.Exit	Press [Enter] to return to display mode		

After performing entry steps 1 - 7, the programming process is completed.

After confirmation of step "8.Exit", the device automatically returns to default display mode; the current tank content is shown in the display.

Special functions are available under entry steps 9 to 24.

After the end of setup, do not forget to replace the housing cover!

After completing the ASSEMBLY and PROGRAMMING, carrying out a function check is recommended (FUNCTION CHECK section).

EXAMPLES FOR PROGRAMMING

Example 1: Basement tank for 6,000 litres heating oil, linear steel tank

Inner height 165cm, (fill level 125cm)

SmartBox[®] 4 with standard levelprobe 0 - 250mbar

Step	Entries / selection
PIN	PIN: 0000 (set with [+] key → press [Enter] to save)
1.Measure probe	250mbar
2.Liquid	Heat.oil
3.Tank shape	Linear
4.Tank volume	6.000L (set with [+] / [-] keys)
5.Tank height	165.0cm (set with [+] / [-] keys)
5b.Filling limit	95%=157cm (set with [+] / [-] keys)
6.View → View details	Fillspace+Percnt (2st line of the display → set with [+] / [-] keys)
7.Relay	Deactive
8.Exit → press [Enter] to see the indication	Heat.oil 4.550L -1.150L 76%

Example 2: Buried tank, cylindrical, horizontal, for 100,600 litres diesel oil

Inner height 2.886m, (fill level 54cm)

SmartBox[®] 4 with standard levelprobe 0 - 250mbar

The relay to be used as an dry-run protection for a pump

Relay - On at > 11% - Off at < 10%

Step	Entries / selection
PIN	PIN: 0000 (set with [+] key → press [Enter] to save)
1.Measure probe	250mbar
2.Liquid	Diesel (set with [+] / [-] keys)
3.Tank shape	Cylindric horiz (set with [+] / [-] keys)
4.Tank volume	100.600L (exact value from volume table, set with [+] / [-] keys)
5.Tank height	288.6cm (exact value from volume table, set with [+] / [-] keys)
5b.Filling limit	97%=279cm (set with [+] / [-] keys)
6.View → View details	Fillspace+Percnt 2st line of the display → set with [+] / [-] keys)
7.Relay → Active → Limiting tank:1	Switch-on: 11% → Switch-off: 10% (set with [+] / [-] keys)
6.Exit → press [Enter] to see the indication	Diesel 12.800L -84.800L 13%

Example 3: Basement tanks for 15,000 litres heating oil, linear steel tank

inner height 220cm, (fill level tank 1 = 125cm)

SmartBox® 4 PRO with 4 standard levelprobes 0 - 250mbar,

Menü-Schritt	Eingaben / Auswahl
PIN	PIN: 0000 (set with [+] key → press [Enter] to save)
Tank number:	1 (2, 3, 4)
1.Measure probe	250mbar
2.Liquid	Heat.oil
3.Tank shape	Linear
4.Tank volume	15.000L (set with [+] / [-] keys)
5.Tank height	220.0cm (set with [+] / [-] keys)
5b.Filling limit	95%=209cm (set with [+] / [-] keys)
6.View tanks → Single/detailed	→ Collective → Percents: Yes (L → Σ → % are displayed alternately)
7.Exit → press [Enter] to see the indication	8.500L 8.520L → Σ 34.120L  8.540L 8.560L 57% 57% 57% 57%
→ For Tank 2-4 repeat the entry with the correct value in the same way as with tank1	

Tanks with inner shell

For tanks with an inner shell (e.g. cylindrical horizontal or tanks welded together in the basement) the data in steps "4.Tank volume" and "5.Internal tank height" must be corrected.

Examples:

- Wall thickness of inner casing 0.5cm → reduce value for inner height by approx. 1cm, reduce volume for 10m³ by 1.3%, for 20m³ by 1 %, for 50m³ by 0.8% and for 100m³ by 0.7 %.
- Wall thickness of inner casing 2cm → reduce value for inner height by approx. 4cm, reduce volume for 10m³ by 5%, for 20m³ by 4%, for 50m³ by 3% and for 100m³ by 2.5%.

NOTES ON PROGRAMMING

Menu	Setting	Description
9.Offset probe	Adjusting:	<ul style="list-style-type: none"> • probe zero point, electric • position / Distance from base • unusable capacity that is not to be displayed
	ESC	Exit the menu
	Offset calibr.	New measurement of probe zero point (electric)  Lift level probe out of the liquid beforehand.
	Probe bottom gap	Probe pos: x cm; normal reference is x = 0cm, max = 99cm
	Bottom deadstock	Sucker position: y cm Normal reference is 0cm = capacity completely displayed. y > 0cm means corresponding unusable capacity.
	Default values	Reset values from menu step 9 to factory settings

Menu	Setting	Description																				
10.Trim height	xxx.x cm	Entry option for the reference height for the 2-point measurement, for other probe measurement range or for an unknown density. Subtract 1.0cm from the actual measured level and enter this value.																				
	Calibrate:No Calibrate:Yes	If activated (Yes), the display in menu steps "1.Measure probe" and "2.Liquid" is then "by Calibration". NOTICE If this is entered with an almost empty tank, it is recommended that you make a correction the next time it is filled.																				
11.Exit		Press [Enter] to return to display mode																				
12.Unit	L default setting m ³ % m kg IG UG t mbar kPa	<table border="0"> <tr> <td>liter:</td> <td>999900L</td> </tr> <tr> <td>cubic meters:</td> <td>2.50m³</td> </tr> <tr> <td>percent:</td> <td>99.50%</td> </tr> <tr> <td>meter:</td> <td>2.50m</td> </tr> <tr> <td>kilogram:</td> <td>999900kg</td> </tr> <tr> <td>imperial Gallon:</td> <td>219750IG</td> </tr> <tr> <td>US liquid gallon:</td> <td>263900UG</td> </tr> <tr> <td>ton:</td> <td>2.50t</td> </tr> <tr> <td>millibar:</td> <td>500mbar</td> </tr> <tr> <td>kilopascals:</td> <td>50kPa</td> </tr> </table>	liter:	999900L	cubic meters:	2.50m ³	percent:	99.50%	meter:	2.50m	kilogram:	999900kg	imperial Gallon:	219750IG	US liquid gallon:	263900UG	ton:	2.50t	millibar:	500mbar	kilopascals:	50kPa
liter:	999900L																					
cubic meters:	2.50m ³																					
percent:	99.50%																					
meter:	2.50m																					
kilogram:	999900kg																					
imperial Gallon:	219750IG																					
US liquid gallon:	263900UG																					
ton:	2.50t																					
millibar:	500mbar																					
kilopascals:	50kPa																					
Menu	Setting	Description																				
13.Rounding	Automatically Without rounding 20L 50L 100L 200L 500L 1.000L	Default settings minimal increments Rounding increments in relation to the set volume set with [+] / [-] keys																				
14.Exit		Press [Enter] to return to display mode																				
15.Modem	Active: Yes/No	Selection...																				
	Send an SMS: No/Yes	Send a test SMS to #T (modem must be logged on)																				
16.Sort tanks → with SmartBox 4	ESC	Exit the menu																				
	Delete Tank n	Delete the registered Tank n (Tank 2, 3, 4)																				
	T2<->T3	Replace Tank 2 for Tank 3																				
	T2<->T4	Replace Tank 2 for Tank 4																				
16.Sort tanks → with SmartBox 4 PRO	T3<->T4	Replace Tank 3 for Tank 4																				
	ESC	Exit the menu																				
	Delete Tank n	Settings for tank n are deleted and reset to default settings (tanks 2, 3, 4)																				

Menu	Setting	Description
17. Input/ Output	Alarm-In →	Sets the function of the alarm contact input
	Closing	Closer alarm. Input closed → Alarm
	Opening	Opener alarm. Input contact opens → Alarm
	Deactiv	⚠ Sets the alarm input functionless
	Data-Out →	Defines the data output on the output adapter slot
	Tank: 1 1-4	For data output a selection can be made between <ul style="list-style-type: none"> • Output single tank 1, 2, 3 or 4 → for analogue adapter • Output "1-4" → all tanks are output sequentially → via digital slot-in adapter – e.g. for H-Box
17b. H protocol	Data output: Deactiv Data: Litres Data: Level	Data output to H Box (only with DTM-2): <ul style="list-style-type: none"> • Deactivated • Output in litres • Output in level
18. Language Names	Language:	German, English, French, Spain [+] / [-] / [Enter]
	Names:	ESC Name Tank 1: Suggested name Letters can be changed with [+] / [-] / [Enter]
19. Exit		Back to display mode
20. LCD display	Contrast: 90	Set the contrast of the LCD display
21. Device info		Displays information about Software version: V7.00 (e. g.) Serial number: Tank 1: SN=1234 (e. g.) Offset+Gain: X0=4.05mA B=1268 (Tank 1)
22. Test current		Test function for the current mA value of the probe : ADC = 28A0 = 04.00mA If level probe is not submerged, the value should be close to 4 mA. Tolerance range is 3.7 ... 4.3 mA. For larger deviations, see menu item 9.
23. Test relay → SmartBox 4	⚠ WARNING	Furthermore, devices connected on the relay contact will also be switched on and/or off! <ul style="list-style-type: none"> • Connected devices can be damaged (dry running). • Operating media may leak. ✓ Disconnect the devices connected before test relay. ✓ Only reconnect the devices again after test relay.
	Relay 1 ON/OFF	Test function for the switch function of relay
24. Reset	ESC	Exit this function without executing it.
	Restart	Initialisation. The device software restarts and keeps all device settings.
	Factory settings	Complete reset of all parameters to the original delivery status.
26. Exit		[Enter] back to display mode.

SmartBox® 4:**Activation of other indicators (and assignation of the respective tank numbers)****Numbering the tanks:**

The contents indicator SmartBox® 4 always has tank number 1.

If other content indicators SmartBox® 1, 2 or 3 (indicator) are to be connected “SERIAL LINK INPUT“ (terminals 3 + 4), they must be assigned defined tank numbers. The tank numbers are simply assigned in the sequence in which the indicators log on for the first time.

- First, activate indicator 2 for tank number 2 (switch on mains voltage), then for indicator 3, and so on.

Example: Activate tank 2

- After connection the indicator of tank 2 as described under Electrical Installation – Connecting the Interface to SmartBox® 1, SmartBox® 2 or SmartBox® 3, switch on the indicator of the tank in question (switch on the mains voltage).

In the display of SmartBox® 4, the following will be indicated alternately: “Tank1:” - “xx.xxxL“ – “Tank2:“ – “yy.yyyL“ (depending on the selection / adjustment in the menu 14.Show tanks). Then, follow the same steps for the other indicators.

You have now completed the on-site installation.



The order of the displayed tanks can be changed subsequently under menu step 16.Sort. Tanks → SmartBox 4 to be changed.

PROGRAMMING THE REMOTE MONITORING FUNCTIONS

If the device is linked to www.smart-inspector.com, this is done via the Internet.

As an alternative, the setting parameters for remote monitoring functions of the SmartBox® can also be transmitted via SMS by any mobile phone. This can be done directly on site or optionally at a later time, e.g. from the company headquarters.

Command to the device (from a mobile phone)

- An SMS may contain one or several commands.
- However, the total length of the SMS must not exceed 80 characters.
- There must be no spaces between the SMS commands and no special characters!
- When entering a chain of commands, the commands **#R** or **#M** or **#C** must come at the end, if applicable.

Setting the SMS target number (number of the receiving building supervisor):

- Enter the SMS text ... #T=01701234567#M (i.e. the number of the reporting mobile phone)
- ... and send it the mobile network number of the SmartBox®.
- Because of #M, the SmartBox® will send an SMS in reply (possibly after 1 - 2 minutes' wait).
- The SmartBox® indicates reception of this SMS by showing “Receive” in the display.
- The transmission of the reporting SMS is indicated by showing “Sending” in the display.

Setting of unit names for the text messages of the system

- Enter the SMS text #H=Tankmonitoring Jones NameofPlace #R
- ... and send it the mobile network number of the SmartBox®.
- Commands as #T=... #H=... and #R can be sent as a chain in one single SMS.

Example: Complete setup by means of one single SMS containing a chain of commands #T=01714901312#H=Ct-024Tankmonit.K.Miller,LevenhamRd.21#P=10,07,15,01#R

See page 22 for a list of all commands.

Messages from the SmartBox®

General, there are two ways to receive fill level measurements or other data from the SmartBox®:

1. Manual inquiry	Data from the SmartBox® can be queried through any mobile phone. To do so, simply send an SMS with a brief command, e.g. #R, to the mobile phone number of the SmartBox®. After approx. 2 - 3 minutes, your mobile phone will receive the answer SMS with the data on tank content(s). In addition to fill level measurements, configuration data of the SmartBox® can be queried as well.
2. Automatic messages	The SmartBox® can send various messages automatically to the www.smart-inspector.com system, to a (monitoring) mobile phone, or to an E-mail address. The following messages are available.

Event causing the message

The following events cause a message to be sent:

Message text	Reason for the message
Info	Cyclical message after n days or after x% reduction of fill level
Info Tank 2	Message at start of fueling process (low level)
Tank filling 2	Fueling Tank 2 - message after fueling, as high-level message, is given approx. 60 min. after start of fueling process
Manually inquiry	Manual system inquiry via SMS command #R or #M
Limit Tank 3	Limit Value Tank 3 - value for tank n has fallen below set message threshold
New tank 2	New tank indicator for tank 2 has been activated/connected
Alarm 1	Signal at alarm input (digital input), e.g. unit malfunction
Check credit	Check credit - the credit on the SIM card has fallen below 1 €. Please top up the credit! (in Germany the credit message only works in the T-Mobile, Vodafone, O ₂ networks)
Test	In the menu item 15.Modem, you can cause the unit to send an SMS by selecting "Send SMS" (+ENTER)
Parameter	Query of the unit settings (configuration) by SMS command #C
Relais on Relais off	This is displayed when the device relay has switched over → only with SB 4 → Conditions: Menu step 7 → Relay 'Activ' is set or #S=2 → Relay 'Activ'+SMS' is set or #S=21

When two events are pending at the same time, the major of the two events is reported in the SMS first (e.g. Alarm 1 before Limit Value Tank 1).

Form of the SMS messages sent by the unit

An SMS message takes the following form:

Header; reason for the message; tank content(s); alarm status; credit/SMS counter; relay status

Header	<p>Freely selectable text.</p> <p>This header text is sent as the first part of each reporting SMS message. It should e.g. contain the customer's number and address etc. Example: Ct-024 Tankmonit. K. Miller, Levenham Rd.21</p>
Reason for the message	<p>Info; Grenzwert Tank x; Betankung tank x; see table above</p>
Tank content	<p>The contents of tanks 1 - 4, if applicable, are mentioned successively in the message text. Example: ... ,100%=9999L, 100%=10.00, 74%=29.65; ... In each case, the percentage and the current liter value is given. Liter values exceeding 9999 l are given as a numerical value with decimal place(s), but without unit, e.g.: 10,00 (cubic meters) or 29,65 (cubic meters) If ???? is reported for a tank, this tank does not provide any current values (the SmartBox® gets no more data from the additional indicator).</p>
Alarm	<p>The status of the alarm input (DIGITAL INPUT) is reported in plain text, e.g.:</p> <ul style="list-style-type: none"> • kein Alarm (no alarm) • Alarm 1 Anlagenstörung → the text Anlagenstoerung (Facility failure) can be changed (Command #A1) • Alarm 1 OK → OK report, i.e. alarm 1 has been cancelled • Alarm Tank n → Tank display device n reports a fault or an alarm • Alarm Tank n OK → OK report; i.e. the fault/alarm has been cancelled • Temp-Alarm n → Tank n has fallen below the set temperature • Temp-Alarm n OK → OK report; i.e. the temp alarm from tank n has been cancelled
Credit or SMS counter	<p>The credit remaining on a prepaid card is indicated if the service provider allows this function (USSD process). In Germany this is possible in the T-Mobile, Vodafone and O₂ networks. For contract cards, this function makes no sense; for them, an SMS counter should be activated, see #G=.</p>
Relais	<p>Rel=0 → Relay OFF ; Rel=1 → Relay ON → only SB 4</p>
Error	<p>Command error: - The SMS only shows this element if an error is pending - The SmartBox® has received a command that is invalid and cannot be processed. Check the format of command → see List of commands</p>
Example message	<p>Ct-024 Tankmonit. K. Miller, Levenham Rd.21; Tank filling 2; 33%=1600L, 40%=40.00, 100%=99.99; no alarm; 14.81 £, Rel=0</p>

LIST OF COMMANDS

The commands to the SmartBox® are sent automatically if the www.smart-inspector.com system is used. Alternatively, they can be sent manually via SMS from a mobile phone. All commands start with the # character (command character).

Command	Parameter	Description	Standard / default value
#T=	Mobile network number for the SMS messages	Mobile phone number to which the automatically generated reporting SMS are sent (e.g. building supervisor, headquarters)	
#TA1= (identical to #TA=)	1. Mobile phone number for alarms	1. Mobile phone number for a fault mobile phone. If for #TA1=... an alarm number is entered, the alarm SMS is sent to this number (approx. 5-minute delay). If no number is entered (field empty), the report is sent to the #T number.	If Smart-Inspector connection exists, this field is empty
#TA2= ... #TA3=	2. + 3. Mobile phone number for alarms	2. + 3. Mobile phone number for a fault mobile phone. The current alarm is reported to this number as 2. / 3. (for delay time, see command #Q=) If this alarm number is not entered (empty), this means that the end of the alarm chain has been reached and that there are no further messages for this alarm.	If Smart-Inspector connection exists, this field is empty
#Q=		Change the delay time for the alarm chain, e.g. #Q=10 sets the delay time to 10 minutes.	20 [1...255]
#H=	Text 0 – 40 signs max.	Header-Text , introducing every SMS message.	Tank monitoring
#P=	10,30,15,07 (always enter 4 values as 2-digit figures, preceded by 0 if necessary!)	Fill level message points:	[from..to]
		Number 1 =	Percentage increment for new message, e.g. report fill level after every 10%. 10, [01..99] %
		Number 2 =	Period of days for new message, e.g. send a report on the system min. every 30 days. Or indicate number of hours with xxh. Add 'h' to indicate a number of hours. 30, [01..99] Tg [01h..24h]
		Number 3 =	'Critical limit value' in per cent, i.e. if the value falls below the limit, an alarm message is sent. 15, [00..99] %
		Number 4 =	Interval of days for repeating the message on limit value. 07, [01..31] days [01h..24h]
	5. Value: 10,30,15,07, 0,5,0	Number 5 = 0 Triggers a limit value report as soon as one of the tanks reaches the reserve level. 1 Triggers a limit value report only when all of the tanks reach the maximum level. 2 Triggers a limit value report as soon as one of the tanks reaches the reserve level. 3 Triggers a limit value report only when all of the tanks reach the maximum level.	0 [0 to 3]

Command	Parameter	Description		Standard / default value
	6. Value: 10,03,15,07, 0,5,0	Number 6 =	Percentage for increase in content, that triggers a fuelling report, e.g. 5%	5 [01..99] %
	7. Value: 10,03,15,07, 0,5,0	Number 7 =	1 or 0. With 1, in a fuelling case a message with the initial value is displayed.	0 [0 oder 1]
#Pn=	#P Change parameters individually	The above #P parameters can also be set individually: e.g. #P6=8 or #P2=36h		
#A1=	Configure alarm 1: 0, "Text"	Configuration: 0 (alarm, when contact closed) 1 (alarm, when contact open) Additional text: e.g.: Boiler cold (max. 15 signs)		0, system fault
#G=	0 - 101	Activate credit information: 0= OFF, no credit information, contract card or other prepaid-SIM-card 1= ON for prepaid-SIM-card T-Mobile (*100# - in Germany) 2= ON for old prepaid-SIM-card Vodafone (**100# - in Germany) 9= SMS counter (recommended for contract SIM-card!) 101= ON for Prepaid-SIM-card O ₂ (*101# - in Germany) 106= ON for new prepaid-SIM-card Vodafone (**106# - in Germany)		9
#Ni=	Enter name for tank i	#N1=Name Tank1 (the name of the tank can have up to 16 characters)		#N1=... to #N4=...
#LG=	Language	#LG=0 sets language to 'German', 1 to 'English', 2 to 'French', 3 to 'Spain'		#LG=0, #LG=1 #LG=2, #LG=3
#TMPn=	Temperature limit value n = tank number	Set temperature limit value in °C e.g.: #TMP1=18#TMP2=5#TMP3=-10#TMP4=-99 Value -99 = Deactivation The lower deviation causes a temperature alarm in alarm chain #TA1...#TAn		-99 [-99..99] °C
#I2 #I3 #I4		Delete tank: The tank with this number is deleted from the tank registry. The tank numbers behind this move up one place. (The previous command #I deleted all tanks).		→ only SmartBox® 4
#I98		Remote reset: Cold start command for processor and modem		

Comm- and	Parameter	Description	Standard / default value
#R		<p>Quick additional inquiry addressed in between to the inquiring mobile phone, e.g. by the driver of the tank truck.</p> <p>Read command to trigger an info SMS to the inquiring mobile phone. The day counters for the standard info SMS to the headquarter will run on.</p>	
#M		<p>Same as #R, but day counters are reset (#P). This is useful e.g. if the tank is to be monitored all the time by manual inquiry only.</p>	
#C		<p>Query configuration Query device configuration: Header; SW version; main destination no.; reporting points; serial no. of the device; field strength; credit mode; SMS counter; Temp. limit value if set with #TMP1 - #TMP4</p> <p>Format: Header; Parameter; V6.00; 004917619808000; 10,2,40,2,0,5; 9308; 2; 9; 123; TMP=-99</p>	
#A		<p>Query alarm texts and alarm bits Query the stored #A1 parameters</p> <p>Format: Header; Alarm-Para; A1:0,Text Alarm1; Alarm-Bits;(+) (PS) 05.02.604 (Modem-ID)</p>	
#TA		<p>Query alarm numbers and alarm delay The alarm numbers in the alarm chain set with #TA= are read. The parameterised delay (#Q=) between two alarms is confirmed.</p> <p>Format: Header; Alarm-Tel; 004917619808000; 0049123456789; 20min</p>	
#Q		Acknowledge alarms. Sending alarms to the subsequent alarm numbers is also stopped.	
#Q+		Acknowledge alarms and subsequent OK messages when alarms are cancelled.	
#S=	<p>#S=0 #S=1 #S=3 #S=2 #S=21</p>	<p>Determines the relay switching functions</p> <p>Switch relay to OFF</p> <p>Switch relay to ON</p> <p>Relay deactivated - the relay is functionless</p> <p>Relay active -switch status depends on the measured value</p> <p>Relay active+SMS - like #S=2 but with SMS</p>	→ only SmartBox® 4

Receive SMS messages as E-mail

Optionally, the messages automatically sent by the SmartBox®, e.g. limit value or alarm, can also be received as E-mails, if the provider allows it.

To this end, a service telephone number and a recipient's e-mail address must be specified in accordance with the respective network operator. As an alternative, the **www.smart-inspector.com** system also provides this function without any extra fee.

Command	Description
#T=8000	Service telephone number for the T-Mobile network (in Germany)
#H=MyEmail@address.com [Leerzeichen][+Header-Text] → insgesamt max. 40 Zeichen	Mention e-mail address first in the header
Example: #T=8000#H=info@gok-online.de HEL-Tank1, Hauptstr.7, 97340 MB	

Remote monitoring with the Smart Inspector system via Internet PC

The Smart Inspector is a web-based database system for comfortable remote monitoring of tank data.

Also in this case, the SmartBox® sends the data via SMS. But all messages of this system are received, logged and processed by the Smart Inspector server.

In case of malfunction, the SMS event messages are forwarded to the mobile phone number indicated by the customer.

For guest access to the Smart Inspector, please go to **www.smart-inspector.com**.

OPERATION

The product requires no operation while it is running.

TROUBLESHOOTING

Error code	Significance
Error E1	The set value is invalid.
Error E2	Measured value too small $I < 3,7\text{mA}$ → probe defective)
Error E3	Measured value too great for zero point calibration (level probe must not be immersed).
Error E4	Measured value not plausible. Check menu item "9. Offset probe".
Error E5	Set height is more than the height of the tank (incorrect entry menu item 10).
Error E6	The current measured value is too low as a reference point. The level probe must be submerged. The set height is too high (the measured value is too low). Check menu item "9. Offset probe". Otherwise, probe fault.
Error E7	The current measured value is too low in relation to the set tank height or to the tank volume. The level probe must be submerged.
Error E8	Measured value (probe current) is too high - check electrical connection and measuring range of the probe, switch power supply off and on again. Check menu settings steps 1 to 5. If necessary, Check menu item "9. Offset probe". Otherwise, probe fault.
Error E9	Probe current = 0mA - no signal current. The probe cable is poled wrongly or interrupted; check cable extension, reconnect if necessary.
Error E10	Calibration error. Disconnect the display device from the power supply, wait 5 sec. and then reconnect. Otherwise, probe fault.
Error E11	CAUTION The liquid level in the tank is actually too low for an exact measurement. You can still press [Enter] to confirm and continue.
Error E12	(Still) no measured value available from ex. tank 2..4 → only SmartBox® 4.

Error regarding GSM modem / telecommunication functions	
Error M0	Modem not active
Error M1	Communication error with the internal modem. (The SmartBox® will automatically perform reset and re-attempt connection).
Error M2	SIM card faulty or illegible
Error M3	PUK must be entered (3 failed attempts to enter the PIN. The SIM card must be inserted into a mobile phone and unblocked by means of the PUK.
Error M4	No credit remaining (only for prepaid card)
Error M5	No net found (bad reception, possibly additional external antenna?)
Error M6	Net error or other error when sending an SMS
Error M7	Log-in not yet performed
Error M8	Dial block (because of too many log-in errors, login is attempted only once per day after 7 days, and after 255 days only once on activation or on manual activation of the OK button)
Error M9	Target telephone number has not been programmed yet. (It is required for sending an SMS, for example for sending the test SMS)

FUNCTION CHECK / MAINTENANCE

We recommend that you check the displayed litre values once per year to make sure that they are correct.

For a simple check, pull the level probe up by its cable so that it hangs above the liquid.

In this status the display device should show 0 litres (+ tolerance).

The probe signal can be checked with menu step "22. Test Current"

At 0 cm fill level → approx. 3.7 – 4.3 mA.

In the event of a considerable deviation, we recommend a replacement. → New probe.

New probe/ replacement of the operating medium

If the installation of a new probe is required and/or a change in the operating medium takes place, then firstly, all of the "standard values" under menu step "9th zero point probe" must be reset to the **factory setting!**

It is also necessary to check, and if required, correct all further set values.

RESTORATION

If the actions described in TROUBLESHOOTING do not lead to a proper restart and if there is no dimensioning problem, the product must be sent to the manufacturer to be checked. Our warranty does not apply in cases of unauthorised interference.

In case of repeated errors or alarm messages (relay output) while the tank content does not reach / remains below the set fill level alarm threshold at the probe element, check the connection line of the signal and probe element for breakage or short-circuit, re-install if necessary.

LIST OF ACCESSORIES

Product description	Information on application	Order no.
DTM-1 data transmission module 0-5 V	Retrofittable module as interface to data transmission, e. g. for the master control system of the building	28 851 00
DTM-3 data transmission module 4-20 mA	Retrofittable module as interface to data transmission, e. g. for the master control system of the building	28 853 00
DTM-4 data transmission module M-Bus	Retrofittable module as interface to data transmission, e. g. for the master control system of the building	28 863 00
Cable junction box IP66, with pressure equalization	To extend the probe cable - e. g. in the dome	28 857 00
Additional antenna	Additional antenna for reception amplification at the SmartBox® 5 - data transmitter	28 858 00

DISPOSAL



To protect the environment, our electrical and electronic appliances may not be disposed of along with household waste.

At the end of its lifespan, each end user is obligated to pass old appliances to a district or area collection point, separate from household waste. This ensures that old appliances are disposed of properly and negative effects on the environment are avoided. Our registration number for the electrical old appliances register (EAR) is: WEEE-Reg.-No. DE 78472800.

PROBES AND ACCESSORY PARTS

Product name	Usage information	Order no.
 ▲ DANGER May not be used in potentially explosive areas. Can cause an explosion or serious injuries.	<ul style="list-style-type: none"> ✓ Must be installed by a specialised company in accordance with local industrial health and safety regulations. ✓ Installation outside the defined EX protection zone. 	
Level probe 0 up to 250 mbar Accuracy class 1%	for non-pressurized tanks with liquid operating medium	28 801 00
Level probe 0 up to 250 mbar Accuracy class 0.5%	for non-pressurized storage tanks with liquid operating medium	28 891 00
Mechanical level gauge type FSA-W 4-20 mA Measuring accuracy: ± 3%	for non-pressurized tanks with liquid operating medium, measurement range: 0 to 2.40 m tank height	28 903 00

Checking the level probe signal: can be checked through menu item 22:

At 0 cm fill level → approx. 3.7 - 4.3 mA.

For 1 m water column → approx. 9 - 11 m (standard level probe with measuring range 250 mbar).

TECHNICAL DATA

Indicator	
Action	Typ 1.B (according to EN 60730-1)
contamination degree	2 (according to EN 60730-1)
Rated impulse voltage	4000V
Supply voltage	230V AC 50Hz
Power input	max. 2VA
Measuring input	4 to 20mA; U ₀ = 20V
Relay output	optional
Switching voltage	max. 250V AC
Switching current	 max. 3,5A
GSM wireless modem	GPRS quad-band (4G / 2G) radio modem, for Nano SIM card – only for SMS communication
Dimensions W/H/D in mm	194 x 130 x 65mm
Ambient temperature	-10°C to +50°C
Housing	Polycarbonat (PC)
Analog output	0 to 5V DC; 4 to 20mA
Resolution	12 Bit
Degree of protection	IP54 acc. to EN 60529

Level probe / Standard probe	
Operating voltage	20V DC
Material	V4A; POM; FPM; PUR
Accuracy	± 1 %
Standard version	250mbar
Installation position	vertically suspended, or horizontally supine
Ambiente temperature operating media	-10°C to +50°C
connection cable	6m
Length of standard probe	without cable: 97mm
	Diameter of probe: 22mm
Degree of protection	IP68 acc. to EN 60529

WARRANTY

We guarantee that the product will function as intended and will not leak during the legally specified period. The scope of our warranty is based on Section 8 of our terms and conditions of delivery and payment.



TECHNICAL CHANGES

All the information contained in this assembly and operating manual is the result of product testing and corresponds to the level of knowledge at the time of testing and the relevant legislation and standards at the time of issue. We reserve the right to make technical changes without prior notice. Errors and omissions excepted. All figures are for illustration purposes only and may differ from actual designs.